



GLAZING CATALOGUE

Effective Date: September 2020

CONTENTS

TPV & TPV Co-Ex Backing Seals	3
Lo-Profile Series TPV Wedges	5
Lo-Profile Series PVC Wedges	6
Tree Series PVC Wedges	7
Non Std PVC Wedges	8
TPV Setting Blocks	9
Miscellaneous	10
Contact List and Ordering Instructions	11

PPL design and deliver innovative, high quality plastic solutions.







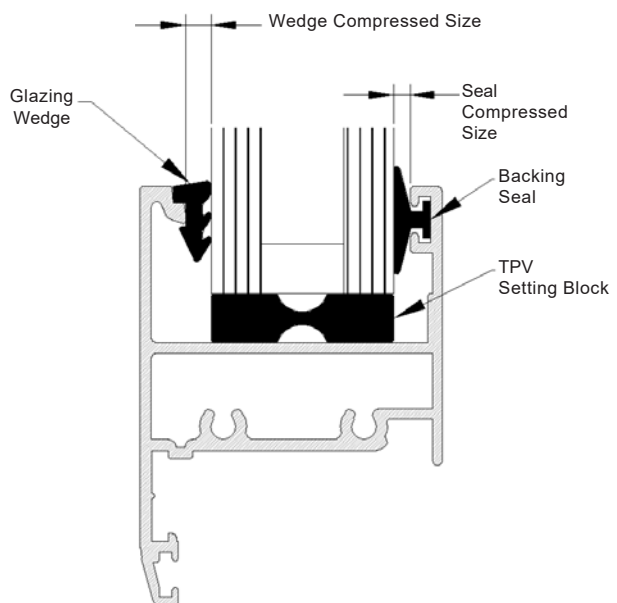



Integrating the latest technology with our highly trained team, exceptional service and dynamic design-and-prototype process is guaranteed to meet expectations.

As New Zealand's leading profile extruder, PPL manufacture a wide range of premium industry products for the glazing, marine, roading, flooring and construction sectors, and custom design profiles for specialist applications.

Visit our website or talk to the team about your current or future plastic profile and injection moulding requirements.



TPV & TPV Co-Ex Backing Seals

IMAGE (not to scale)	PRODUCT NUMBER	DESCRIPTION	COMPRESSED SIZE (MM)	M/COIL
	9010031	Push-in Foot Backing Seal	1.0	500
	9010035DK	Co-Ex Backing Seal (5mm Foot)	1.0	500
	9010080	Push-in Foot Backing Seal	2.0	250
	9010100	Co-Ex Backing Seal (4.5mm Foot)	2.0	300
	9010102	Soft Foot Backing Seal	2.0 (firm compression seal)	250
	9010104	Co-Ex Backing Seal (4.5mm Foot)	2.0 (firm compression seal)	250
	9010313	Push-in Foot Backing Seal	4.0	200
	94053	Co-Ex Bulb Seal (5mm Foot)	2.0	300
	94361 ***	Co-Ex Louvre / Single Leaf Seal	4.0	3M (cut length)
	20500	Co-Ex Single Leaf Backing Seal (5mm Foot)	1.5	300
	20502	Pro-Fit Backing Seal	2.0	300
	20503	Co-Ex Flat Backing Seal (5mm Foot)	0.8	400
	20504	Co-Ex Backing Seal (5mm Foot)	1.5	300
	20505	Push-in Foot Retro Seal	6.0	250

NOTES: Product is available ex stock Hamilton / Christchurch (confirm at time of order).
Available in coil sizes indicated.
*** Made to order or minimum run sizes may apply. (Confirm at time of order).

* PVC seals and wedges should not be used on Polycarbonate sheeting and on any building above 10m high











TPV & TPV Co-Ex Backing Seals continued

IMAGE (not to scale)	PRODUCT NUMBER	DESCRIPTION	COMPRESSED SIZE (MM)	M/COIL
	20506	Co-Ex Captive Wedge (5mm Foot)	4.0	200
	20510	Co-Ex Bi-Fold Door Seal (5mm Foot)	5.0	250
	20511	Co-Ex Door Leaf seal (5mm Foot)	4.0	250
	20512	Co-Ex Captive Wedge (5mm Foot)	2.5	250
	20513	Co-Ex Backing Seal (5mm Foot)	1.5	400
	20514	Co-Ex Backing Seal (Wide Neck)	1.5	300
	20515	Pro Fit Flat Backing Seal	1.0	500

NOTES: Product is available ex stock Hamilton / Christchurch (confirm at time of order).
Available in coil sizes indicated.
*** Made to order or minimum run sizes may apply. (Confirm at time of order).

* PVC seals and wedges should not be used on Polycarbonate sheeting and on any building above 10m high

Lo-Profile Series TPV Wedges

IMAGE (Not To Scale)	PRODUCT NUMBER	DESCRIPTION	COMPRESSED SIZE (MM)	M/COIL
	9010520	TPV Glazing Wedge - Grey	2.0	400
	9010525	TPV Glazing Wedge - Blue	2.5	400
	9010530	TPV Glazing Wedge - Purple	3.0	300
	9010535	TPV Glazing Wedge - Red	3.5	250
	9010540	TPV Glazing Wedge - Orange	4.0	250
	9010545	TPV Glazing Wedge - Yellow	4.5	250
	9010550	TPV Glazing Wedge - White	5.0	200
	9010555	TPV Glazing Wedge - Green	5.5	150
	9010560	TPV Glazing Wedge - Brown	6.0	150
	9010570	TPV Glazing Wedge - Black	7.0	150
	9010580	TPV Glazing Wedge - Big Blue	8.0	150
	9010585	TPV Glazing Wedge - Big Red	8.5	100
	9010590	TPV Glazing Wedge - Pink	9.0	100

NOTES: Product is available ex stock Hamilton / Christchurch (confirm at time of order).
Available in coil sizes indicated.
*** Made to order or minimum run sizes may apply. (Confirm at time of order).

* PVC seals and wedges should not be used on Polycarbonate sheeting and on any building above 10m high









Lo-Profile Series PVC Wedges

IMAGE (not to scale)	PRODUCT NUMBER	DESCRIPTION	COMPRESSED SIZE (MM)	M/COIL
	9010220	PVC Glazing Wedge - Grey	2.0	400
	9010225	PVC Glazing Wedge - Blue	2.5	400
	9010230	PVC Glazing Wedge - Purple	3.0	300
	9010235	PVC Glazing Wedge - Red	3.5	250
	9010240	PVC Glazing Wedge - Orange	4.0	250
	9010245	PVC Glazing Wedge - Yellow	4.5	250
	9010250	PVC Glazing Wedge - White	5.0	200
	9010255	PVC Glazing Wedge - Green	5.5	150
	9010260	PVC Glazing Wedge - Brown	6.0	150
	9010270	PVC Glazing Wedge - Black	7.0	150
	9010280	PVC Glazing Wedge - Big Blue	8.0	150
	9010285	PVC Glazing Wedge - Big Red	8.5	100
	9010290	PVC Glazing Wedge - Pink	9.0	100
	9010295	PVC Glazing Wedge - Big Purple	9.5	75
	9010299	PVC Glazing Wedge - Big Orange	10.0	75

NOTES: Product is available ex stock Hamilton / Christchurch (confirm at time of order).
Available in coil sizes indicated.
*** Made to order or minimum run sizes may apply. (Confirm at time of order).

* PVC seals and wedges should not be used on Polycarbonate sheeting and on any building above 10m high



Tree Series PVC Wedges

IMAGE (not to scale)	PRODUCT NUMBER	DESCRIPTION	COMPRESSED SIZE (MM)	M/COIL
	30230	Tree PVC Wedge - Purple	3.0	200
	30235	Tree PVC Wedge - Red	3.5	150
	30237	Tree PVC Wedge - Black	3.7	150
	30240	Tree PVC Wedge - Orange	4.0	150
	30245	Tree PVC Wedge - Yellow	4.5	100
	30250	Tree PVC Wedge - White	5.0	100
	30255	Tree PVC Wedge - Green	5.5	75
	30260	Tree PVC Wedge - Brown	6.0	75
	30275	Tree PVC Wedge - Blue	7.5	50





NOTES: Product is available ex stock Hamilton / Christchurch (confirm at time of order).
Available in coil sizes indicated.
*** Made to order or minimum run sizes may apply. (Confirm at time of order).

* PVC seals and wedges should not be used on Polycarbonate sheeting and on any building above 10m high

Non Std PVC Wedges

IMAGE (not to scale)	PRODUCT NUMBER	DESCRIPTION	COMPRESSED SIZE (MM)	M/COIL
	30215	1.5mm PVC Wedge (Hard Back)	1.5	200
	30220	2.0mm PVC Wedge	2.0	200
	30302	11.5mm PVC Wedge	11.5	50















Clear Series PVC Wedges

IMAGE (not to scale)	PRODUCT NUMBER	DESCRIPTION	COMPRESSED SIZE (MM)	M/COIL
	30130	Clear PVC Wedge	3.0 (Extra Small)	150
	30137	Clear PVC Wedge	3.7 (Small)	150
	30140	Clear PVC Wedge	4.5 (Med)	150
	30150	Clear PVC Wedge	5.5 (Lrg)	150

NOTES: Product is available ex stock Hamilton / Christchurch (confirm at time of order).
Available in coil sizes indicated.
*** Made to order or minimum run sizes may apply. (Confirm at time of order).





* PVC seals and wedges should not be used on Polycarbonate sheeting and on any building above 10m high

TPV Setting Blocks

IMAGE (not to scale)	PRODUCT NUMBER	DESCRIPTION	BLOCK SIZE (MM)	PACK SIZE
	10580	Single Glazed TPV Setting Block	10 X 3 X 150MM	100/bag 3000/box
	10581	Single Glazed TPV Setting Block	10 X 6 X 150MM	100/bag 2000/box
	10582	Single Glazed TPV Setting Block	10 X 9 X 150MM	100/bag 2000/box
	10583	Single Glazed TVP Setting Block	10 X 12 X 150MM	100/bag 1000/box
	10590	TPV Setting Block	18 X 6 X 100MM	100/bag 2000/box
	10591	TPV Setting Block	22 X 6 X 100MM	100/bag 1000/box
	10592	TPV Setting Block	26 X 6 X 100MM	100/bag 1000/box
	10593	TPV Setting Block	32 X 6 X 100MM	100/bag 1000/box
	10594	Stepped TPV Setting Block	26 X 6 X 4 X 50MM	100/bag 2000/box
	10595	TPV Setting Block	26 X 3 X 50MM	100/bag 2500/box
	10596	TPV Setting Block	26 X 6 X 50MM	100/bag 2000/box
	10597	TPV Setting Block	26 X 1.5 X 50MM	100/bag 3000/box
	10601	15° TPV Sloped Setting Block	-	100/bag 2000/box
	10602	Stepped TPV Setting Block	28 X 8 X 6 X 50MM	100/bag 1000/box
	10603	Bevel TPV Setting Block	26 X 6 X 100MM	100/bag 1000/box

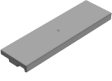
NOTES: Product is available ex stock Hamilton / Christchurch (confirm at time of order).
Available in coil sizes indicated.
*** Made to order or minimum run sizes may apply. (Confirm at time of order).

Miscellaneous

IMAGE (not to scale)	PRODUCT NUMBER	DESCRIPTION	PACK SIZE
	9050723	APL DG Setting Block (First, Vantage & Altherm)	200 per/box
	9050905	Sash Riser Block	100 per/bag 2000 per/box
	9100007	WGANZ Flashing End Cap	250 per/bag 1000 per/box
	9100010	WGANZ Support Block	100 per/bag 600 per/box

NOTES: Product is available ex stock Hamilton / Christchurch (confirm at time of order).
Available in pack sizes indicated.
*** Made to order or minimum run sizes may apply. (Confirm at time of order).
9050723 is manufactured from polypropylene and complies with the WGANZ
glazing block standards.

CONTACT US

Account Manager

Mike Callaghan - 027 270 8169
mike.callaghan@pplplastics.co.nz

Account Manager

Chris Davison - 027 809 4499
chris.davison@pplplastics.co.nz

Customer Service

Oliver Knight - 07 850 5984
orders@pplplastics.co.nz

ORDER

Email orders@pplplastics.co.nz

Phone 07 850 5984

We provide nationwide overnight delivery.
To ensure you receive your products on time, please place your order before 12.30pm.

HAMILTON

Head Office and Distribution

P +64 7 850 5984

E sales@pplplastics.co.nz

2b Karewa Place
Pukete
PO Box 10080
Hamilton
NEW ZEALAND 3241

CHRISTCHURCH

South Island Distribution

P +64 7 850 5984

E sales@pplplastics.co.nz

28 Ballarat Way
Wigram
PO Box 11052
Christchurch
NEW ZEALAND 8443

  pplplastics.co.nz

