



 **PPL**
PLASTIC SOLUTIONS

**GLAZING
CATALOGUE**

CONTENTS

TPV & TPV Co-Ex Backing Seals	3
Lo-Rise Series TPV Wedges	4
Lo-Rise Series PVC Wedges	5
Tree Series PVC Wedges	6
Non Std PVC Wedges / Spline	7
TPV Setting Blocks	8
Contact List and Ordering Instructions	9

PPL design and deliver innovative, high quality plastic solutions.

Integrating the latest technology with our highly trained team, exceptional service and dynamic design-and-prototype process is guaranteed to meet expectations.

As New Zealand's leading profile extruder, PPL manufacture a wide range of premium industry products for the glazing, marine, roading, flooring and construction sectors, and custom design profiles for specialist applications.

Visit our website or talk to the team about your current or future plastic profile and injection moulding requirements.

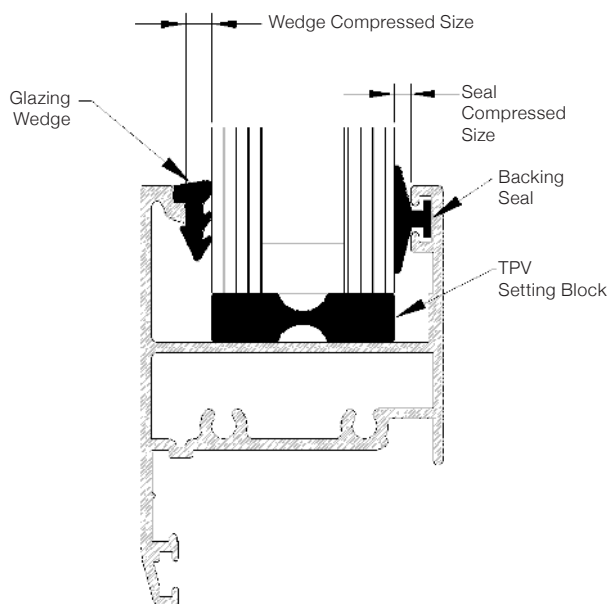

TPV & TPV Co-Ex Backing Seals

EFFECTIVE 1 OCTOBER 2018











IMAGE (not to scale)	PRODUCT NUMBER	DESCRIPTION	COMPRESSED SIZE (MM)	M/COIL
	9010031	Push-in Foot Backing Seal	1.0	500
	9010035	Co-Ex Backing Seal (4.5mm Foot)	1.0	500
	9010080	Push-in Foot Backing Seal	2.0	250
	9010100	Co-Ex Backing Seal (4.5mm Foot)	2.0	300
	9010102	Soft Foot Backing Seal	2.0 <small>(firm compression seal)</small>	250
	9010104	Co-Ex Backing Seal (4.5mm Foot)	2.0 <small>(firm compression seal)</small>	250
	9010313	Push-in Foot Backing Seal	4.0	200
	94053	Co-Ex Bulb Seal (5mm Foot)	2.0	300
	94361 ***	Co-Ex Louvre / Single Leaf Seal	4.0	3M (cut length)
	20500	Co-Ex Single Leaf Backing Seal (5mm Foot)	1.5	400
	20502	Pro-Fit Backing Seal	2.0	300
	20503	Co-Ex Flat Backing Seal (5mm Foot)	0.8	400
	20504	Co-Ex Backing Seal (5mm Foot)	1.5	300
	20505	Push-in Foot Retro Seal	6.0	250
	20506	Co-Ex Captive Wedge (5mm Foot)	4.0	200
	20510	Co-Ex Bi-Fold Door Seal (5mm Foot)	5.0	250
	20511	Co-Ex Door Leaf seal (5mm Foot)	4.0	250
	20512	Co-Ex Captive Wedge (5mm Foot)	2.5	250
	20513	Co-Ex Backing Seal (5mm Foot)	1.5	400
	20514	Co-Ex Backing Seal (Wide Neck)	1.5	300

NOTES: Product is available ex stock Hamilton / Christchurch (confirm at time of order).
Available in coil sizes indicated.
*** Made to order or minimum run sizes may apply. (Confirm at time of order).

* PVC seals and wedges should not be used on Polycarbonate sheeting and on any building above 10m high

Lo-Rise Series TPV Wedges

EFFECTIVE 1 OCTOBER 2018









IMAGE (Not To Scale)	PRODUCT NUMBER	DESCRIPTION	COMPRESSED SIZE (MM)	M/COIL
	9010520	TPV Glazing Wedge - Grey	2.0	400
	9010525	TPV Glazing Wedge - Blue	2.5	400
	9010530	TPV Glazing Wedge - Purple	3.0	400
	9010535	TPV Glazing Wedge - Red	3.5	250
	9010540	TPV Glazing Wedge - Orange	4.0	250
	9010545	TPV Glazing Wedge - Yellow	4.5	250
	9010550	TPV Glazing Wedge - White	5.0	200
	9010555	TPV Glazing Wedge - Green	5.5	150
	9010560	TPV Glazing Wedge - Brown	6.0	150
	9010570	TPV Glazing Wedge - Black	7.0	150
	9010580	TPV Glazing Wedge - Big Blue	8.0	150
	9010585	TPV Glazing Wedge - Big Red	8.5	100
	9010590	TPV Glazing Wedge - Pink	9.0	100

NOTES: Product is available ex stock Hamilton / Christchurch (confirm at time of order).
Available in coil sizes indicated.
*** Made to order or minimum run sizes may apply. (Confirm at time of order).

* PVC seals and wedges should not be used on Polycarbonate sheeting and on any building above 10m high

Lo-Rise Series PVC Wedges

EFFECTIVE 1 OCTOBER 2018









IMAGE (not to scale)	PRODUCT NUMBER	DESCRIPTION	COMPRESSED SIZE (MM)	M/COIL
	9010220	PVC Glazing Wedge - Grey	2.0	400
	9010225	PVC Glazing Wedge - Blue	2.5	400
	9010230	PVC Glazing Wedge - Purple	3.0	400
	9010235	PVC Glazing Wedge - Red	3.5	250
	9010240	PVC Glazing Wedge - Orange	4.0	250
	9010245	PVC Glazing Wedge - Yellow	4.5	250
	9010250	PVC Glazing Wedge - White	5.0	200
	9010255	PVC Glazing Wedge - Green	5.5	150
	9010260	PVC Glazing Wedge - Brown	6.0	150
	9010270	PVC Glazing Wedge - Black	7.0	150
	9010280	PVC Glazing Wedge - Big Blue	8.0	150
	9010285	PVC Glazing Wedge - Big Red	8.5	100
	9010290	PVC Glazing Wedge - Pink	9.0	100
	9010295	PVC Glazing Wedge - Big Purple	9.5	75
	9010299	PVC Glazing Wedge - Big Orange	10.0	75

NOTES: Product is available ex stock Hamilton / Christchurch (confirm at time of order).
Available in coil sizes indicated.
*** Made to order or minimum run sizes may apply. (Confirm at time of order).

* PVC seals and wedges should not be used on Polycarbonate sheeting and on any building above 10m high

Tree Series PVC Wedges

EFFECTIVE 1 OCTOBER 2018

IMAGE (not to scale)	PRODUCT NUMBER	DESCRIPTION	COMPRESSED SIZE (MM)	M/COIL
	30230	Tree PVC Wedge - Purple	3.0	200
	30235	Tree PVC Wedge - Red	3.5	150
	30237	Tree PVC Wedge - Black	3.7	150
	30240	Tree PVC Wedge - Orange	4.0	150
	30245	Tree PVC Wedge - Yellow	4.5	100
	30250	Tree PVC Wedge - White	5.0	100
	30255	Tree PVC Wedge - Green	5.5	75
	30260	Tree PVC Wedge - Brown	6.0	75
	30275	Tree PVC Wedge - Blue	7.5	50

NOTES: Product is available ex stock Hamilton / Christchurch (confirm at time of order).
Available in coil sizes indicated.
*** Made to order or minimum run sizes may apply. (Confirm at time of order).

* PVC seals and wedges should not be used on Polycarbonate sheeting and on any building above 10m high

Non Std PVC Wedges



EFFECTIVE 1 OCTOBER 2018

IMAGE (not to scale)	PRODUCT NUMBER	DESCRIPTION	COMPRESSED SIZE (MM)	M/COIL
	30215	1.5mm PVC Wedge (Hard Back)	1.5	200
	30220	2.0mm PVC Wedge	2.0	200
	30302	11.5mm PVC Wedge	11.5	50

Clear Series PVC Wedges

IMAGE (not to scale)	PRODUCT NUMBER	DESCRIPTION	COMPRESSED SIZE (MM)	M/COIL
	30130	Clear PVC Wedge	3.0 (Extra Small)	150
	30137	Clear PVC Wedge	3.7 (Small)	150
	30140	Clear PVC Wedge	4.5 (Med)	150
	30150	Clear PVC Wedge	5.5 (Lrg)	150

PVC Spline

IMAGE (not to scale)	PRODUCT NUMBER	DESCRIPTION	COMPRESSED SIZE (MM)	M/COIL
	20301.60 ***	PVC Black Spline	6.0	200
	20301.63 ***	PVC Black Spline	6.3	200
	20301.65 ***	PVC Black Spline	6.5	200















NOTES: Product is available ex stock Hamilton / Christchurch (confirm at time of order).
Available in coil sizes indicated.

*** Made to order or minimum run sizes may apply. (Confirm at time of order).

* PVC seals and wedges should not be used on Polycarbonate sheeting and on any building above 10m high

TPV Setting Blocks

EFFECTIVE 1 OCTOBER 2018

IMAGE (not to scale)	PRODUCT NUMBER	DESCRIPTION	BLOCK SIZE (MM)	PACK SIZE
	10590	Db Glazed TPV Setting Block	18 X 6MM	100x100mm 2000/box
	10591	Db Glazed TPV Setting Block	22 X 6MM	100x100mm 1000/box
	10592	Db Glazed TPV Setting Block	26 X 6MM	100x100mm 1000/box
	10593	Db Glazed TPV Setting Block	32 X 6MM	100x100mm 1000/box
	10594	Stepped TPV Setting Block	26 X 6 X 4MM	100x50mm 2000/box
	10595	TPV Setting Block	26 X 3MM	100x50mm 2500/box
	10596	TPV Setting Block	26 X 6MM	100x50mm 2000/box
	10597	TPV Setting Block	26 X 1.5MM	100x50mm 3000/box
	10580	Std Glazed TPV Setting Block	10 X 3MM	100x150mm 3000/box
	10581	Std Glazed TPV Setting Block	10 X 6MM	100x150mm 2000/box
	10582	Std Glazed TPV Setting Block	10 X 9MM	100x150mm 2000/box
	10583	Std Glazed TPV Setting Block	10 X 12MM	100x150mm 1000/box
	10601	15° TPV Sloped Setting Block	-	100x50mm 2000/box
	10602	Stepped TPV Setting Block	28 X 8 X 6MM	100x50mm 2000/box
	10603	TPV Setting Block Bevel Cnr	26 x 6mm	100x100mm 2000/box

NOTES: Product is available ex stock Hamilton / Christchurch (confirm at time of order).
Available in coil sizes indicated.
*** Made to order or minimum run sizes may apply. (Confirm at time of order).

* PVC seals and wedges should not be used on Polycarbonate sheeting and on any building above 10m high

CONTACT US

Account Manager

Chris Davison - 027 809 4499
chris.davison@pplplastics.co.nz

Customer Service

Vanessa Keith - 07 850 5984
orders@pplplastics.co.nz

Operations Manager

Murray Jorgensen - 027 559 9814
murray.jorgensen@pplplastics.co.nz

General Manager

Ian Baines - 027 246 0119
ian.baines@pplplastics.co.nz

ORDER

Email orders@pplplastics.co.nz

Phone 07 850 5984

**We provide nationwide overnight delivery.
To ensure you receive your products on time, please place your order before 12.30pm.**





HAMILTON

Head Office and Distribution

P +64 7 850 5984
E sales@pplplastics.co.nz

2b Karewa Place
PO Box 10080
Hamilton
NEW ZEALAND 3241

pplplastics.co.nz

CHRISTCHURCH

South Island Distribution

P +64 7 850 5984
E sales@pplplastics.co.nz

110 Wigram Road
PO Box 11052
Christchurch
NEW ZEALAND 8443

